

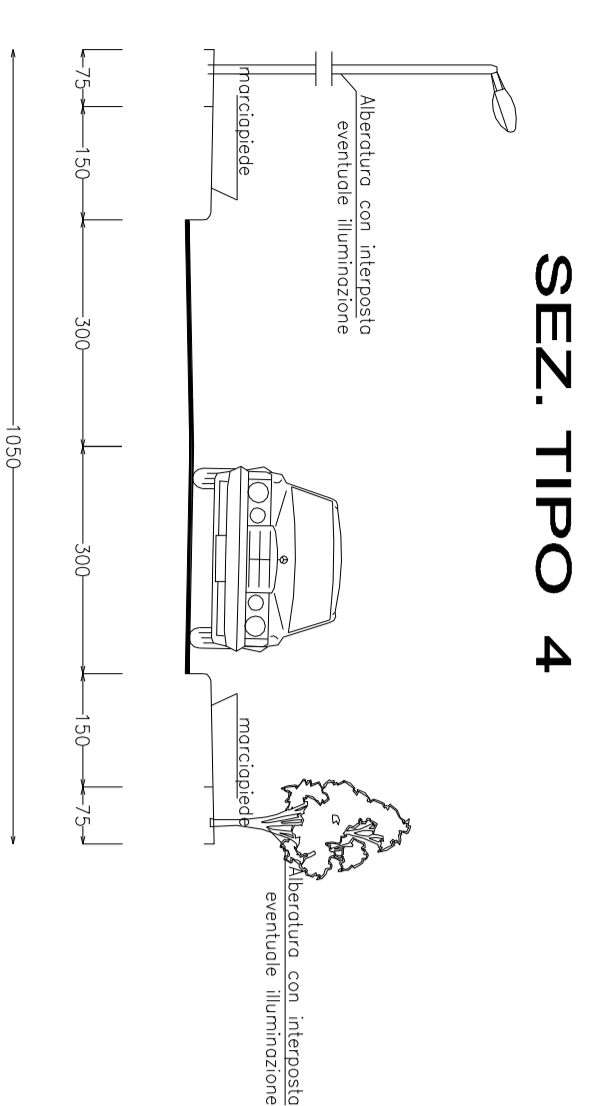

COMUNE DI CASTELLANA SICULA
 PROVINCIA DI PALERMO
UFFICIO TECNICO COMUNALE

**Progetto di revisione del
 PIANO REGOLATORE GENERALE**
 VISTI:

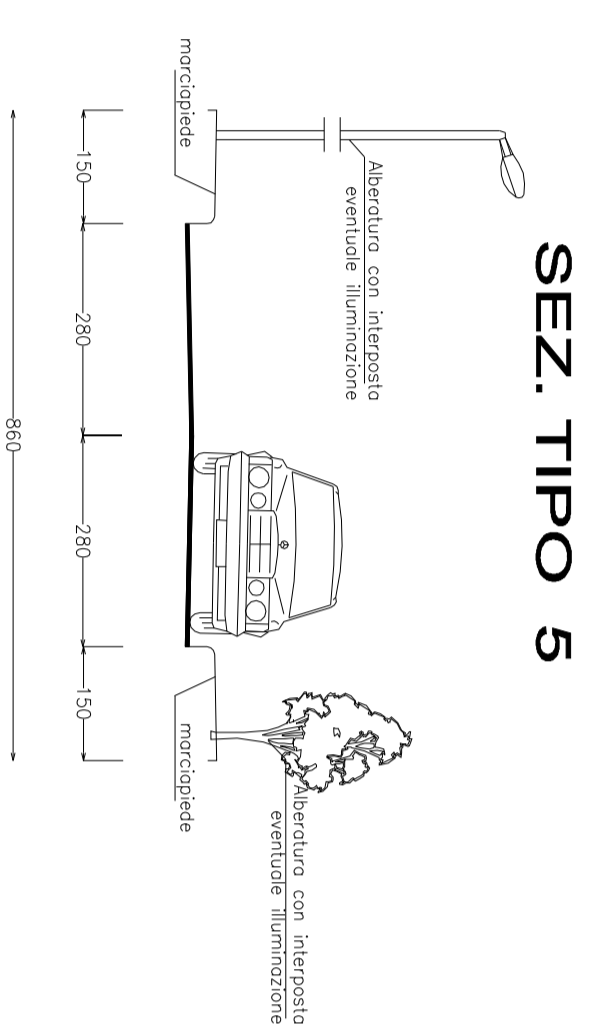
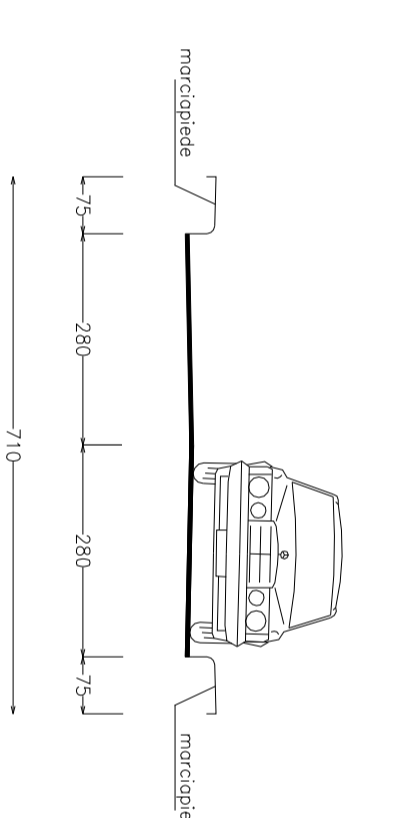
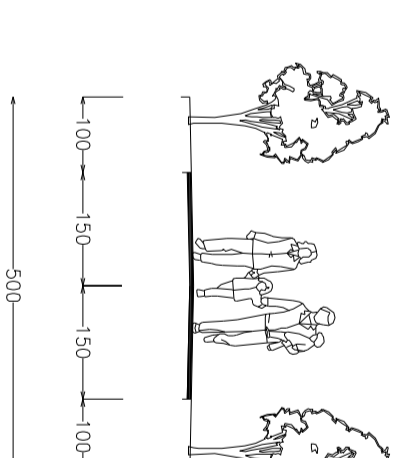
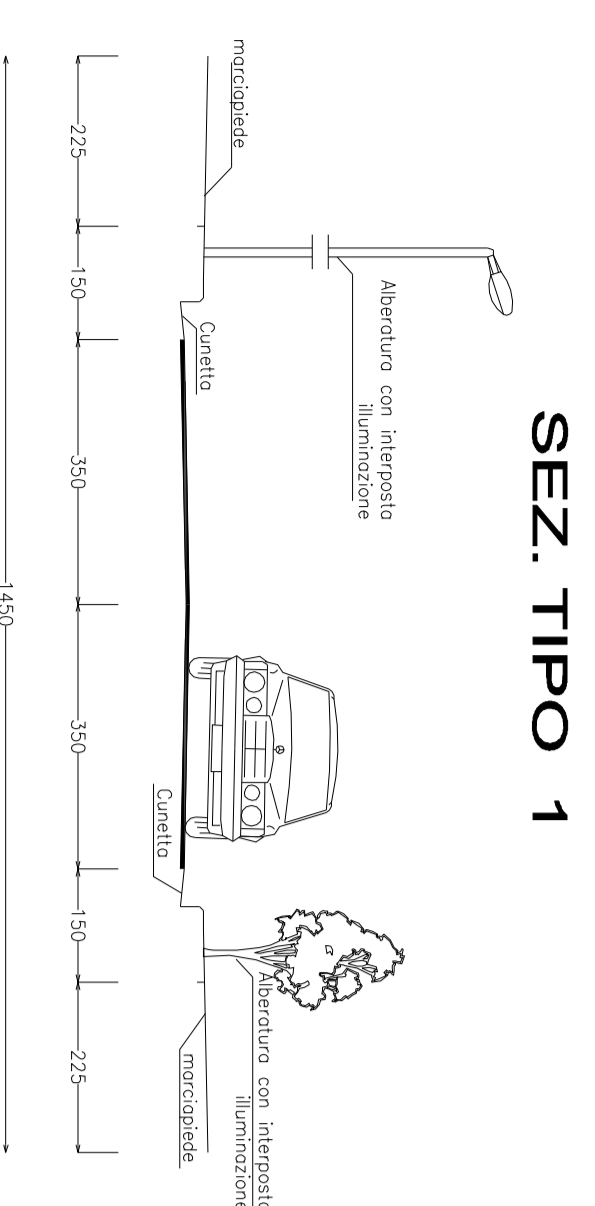
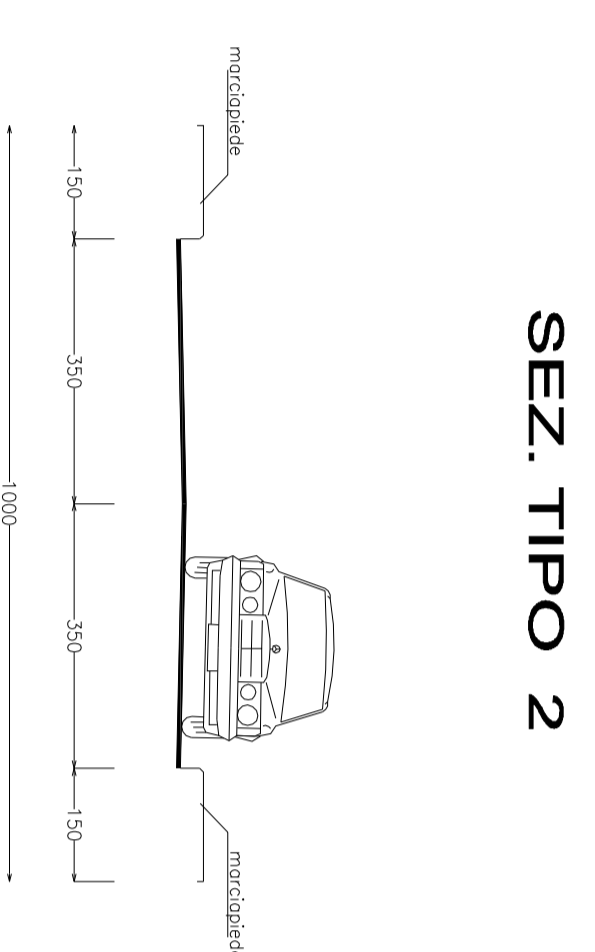
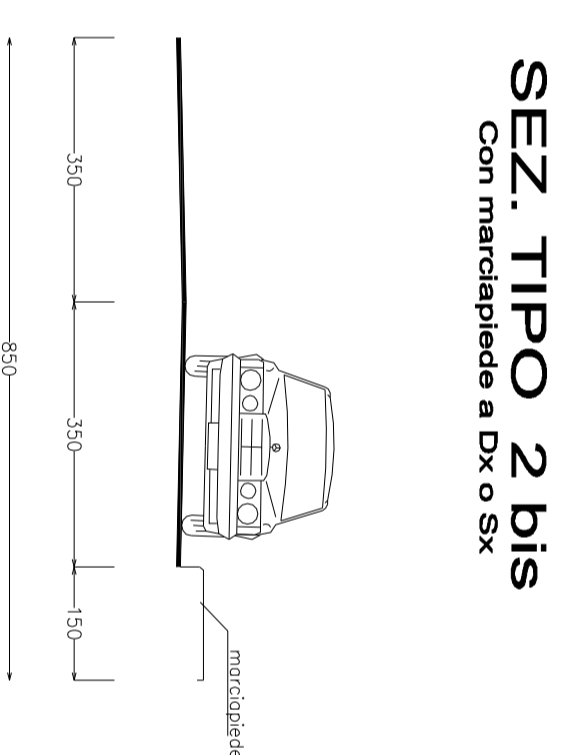
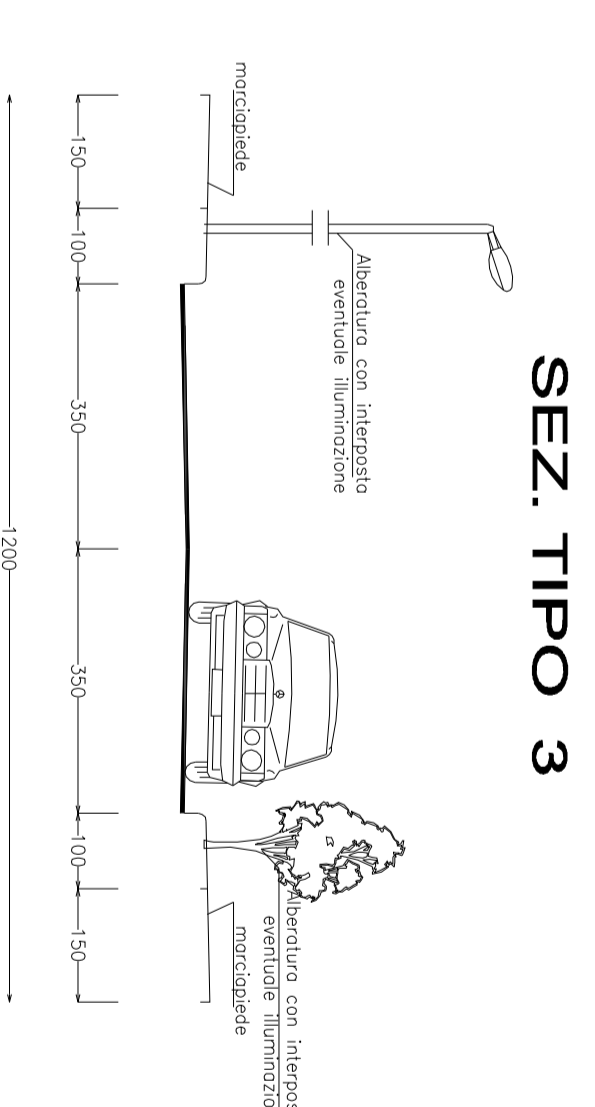

ELABORATO: **Sezioni stradali di progetto**
 PROGETTISTI: **UFFICIO DI PIANO**

Geom. Rastino Carmelo **Dot. Ing. Consosegni Pietro**
 Collab. **Geom. Fallico S. - Calisto M. - Ginefa L.**

Il Consulente Urbanistico: **Dot. Ing. Tummarello Sergio** Il Geologo: **Dot. Abate Giuseppe**
 Il Redattore della VRS: **Dot. ssa Sambataro Samira** Il Segretario Comunale: **Dot. Bruno R.**
 Studio Agr. For. le: **Dot.ssa Marchialino Daniela** Il Sindaco: **Dot. Minichè Giuseppe**

DATA: **Luglio 2009** SCALA: **1 : 100** Tavolo: **3** Allegato: **9**